

ZÊNITE SQUARE 16

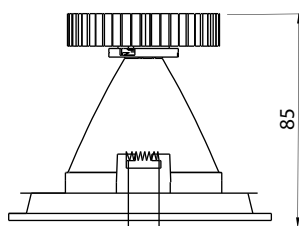

Imagem meramente ilustrativa - Cor Branco texturizado

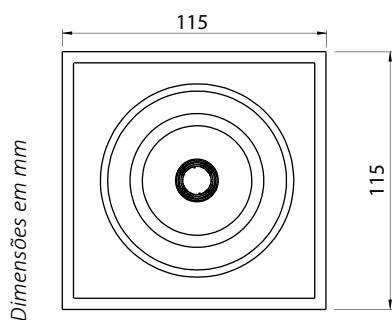

MATERIAL

Alumínio extrudado e refletor metalizado

ACABAMENTO

Pintura eletrostática a pó

CONFORTO VISUAL

Recuo anti-ofuscamento

FOCO

Orientável, sistema orbital

CORES:

- Branco texturizado
- Preto texturizado

! Soluções com outras potências, temperaturas de cor, IRC > 90 e equipamentos Dimerizáveis / DALI sob consulta.

Fonte de luz	Ângulo de abertura	IRC	Equipamento auxiliar
LED	10° / 15° / 24° / 38° / 45° / 60°	> 80	Driver 220 V

Código	Potência	Fluxo luminoso	Eficiência	Temperatura de cor	Corrente	Medidas
EB-ZES16-LED6.8220V827	6,8 W	1.014 lm	149 lm/W	2.700 K	200 mA	L 115 x A 115 x C 85 mm / Nicho 103 mm
EB-ZES16-LED8.7220V827	8,7 W	1.247 lm	143 lm/W	2.700 K	250 mA	L 115 x A 115 x C 85 mm / Nicho 103 mm
EB-ZES16-LED6.8220V830	6,8 W	1.059 lm	156 lm/W	3.000 K	200 mA	L 115 x A 115 x C 85 mm / Nicho 103 mm
EB-ZES16-LED8.7220V830	8,7 W	1.303 lm	150 lm/W	3.000 K	250 mA	L 115 x A 115 x C 85 mm / Nicho 103 mm
EB-ZES16-LED6.8220V840	6,8 W	1.092 lm	161 lm/W	4.000 K	200 mA	L 115 x A 115 x C 85 mm / Nicho 103 mm
EB-ZES16-LED8.7220V840	8,7 W	1.344 lm	154 lm/W	4.000 K	250 mA	L 115 x A 115 x C 85 mm / Nicho 103 mm